

EURO SLIDING SERIES-27MM

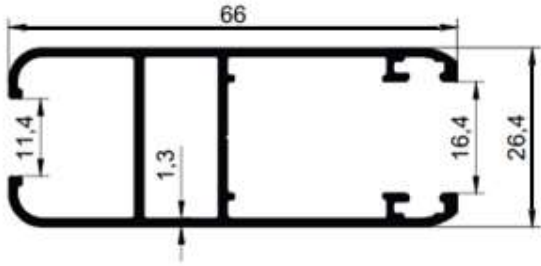

SL.NO.	SECTION NO.	WEIGHT(KG/M)
1	2801	0.758

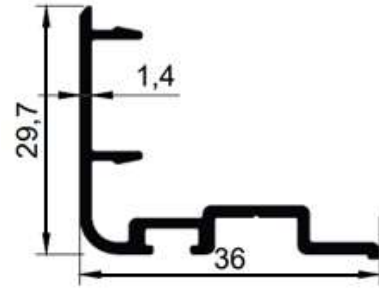

SL.NO.	SECTION NO.	WEIGHT(KG/M)
1	2802	0.327

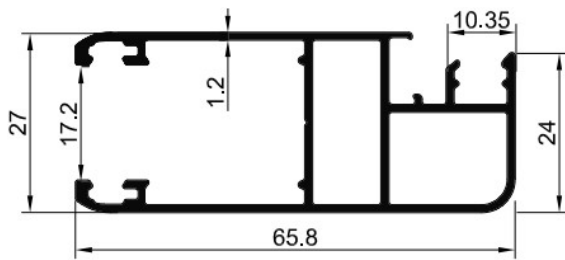

SL.NO.	SECTION NO.	WEIGHT(KG/M)
1	2803	0.775

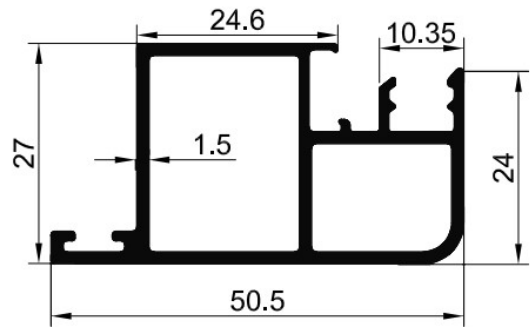

SL.NO.	SECTION NO.	WEIGHT(KG/M)
1	2804	0.695

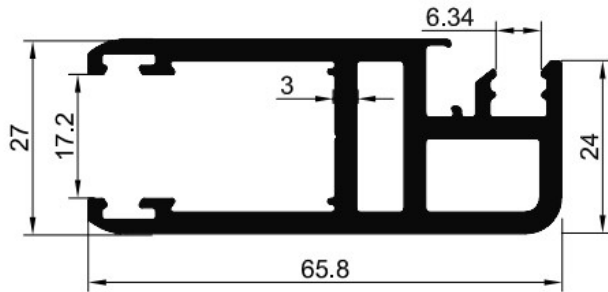

SL.NO.	SECTION NO.	WEIGHT(KG/M)
1	2805	1.579

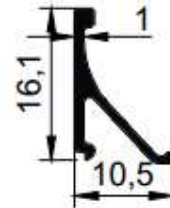

SL.NO.	SECTION NO.	WEIGHT(KG/M)
1	2806	0.087

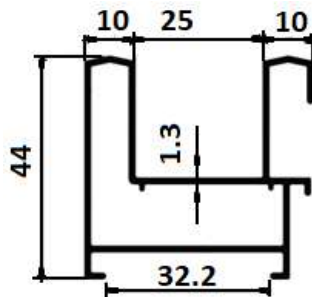

SL.NO.	SECTION NO.	WEIGHT(KG/M)
1	2807	0.765

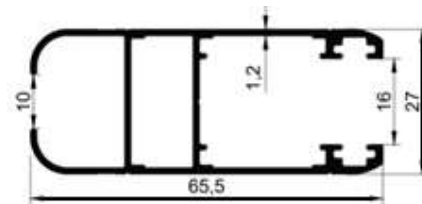

SL.NO.	SECTION NO.	WEIGHT(KG/M)
1	2808	0.747

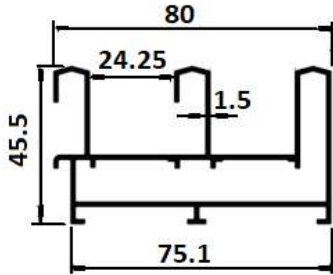

SL.NO.	SECTION NO.	WEIGHT(KG/M)
1	2809	1.413

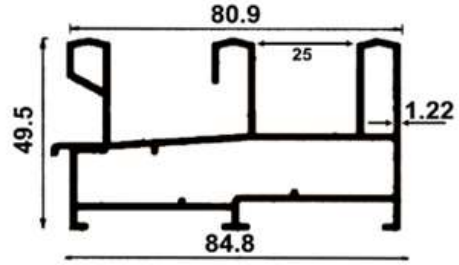

SL.NO.	SECTION NO.	WEIGHT(KG/M)
1	2800	1.271

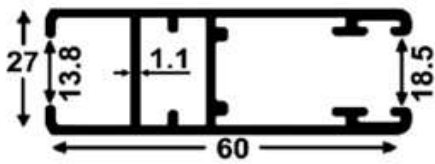

SL.NO.	SECTION NO.	WEIGHT(KG/M)
1	2821	0.656

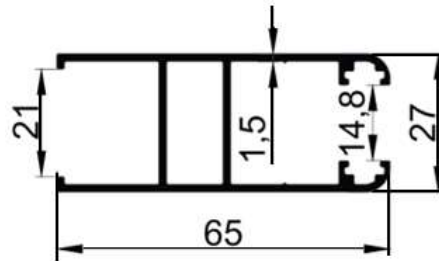

SL.NO.	SECTION NO.	WEIGHT(KG/M)
1	2822	0.822

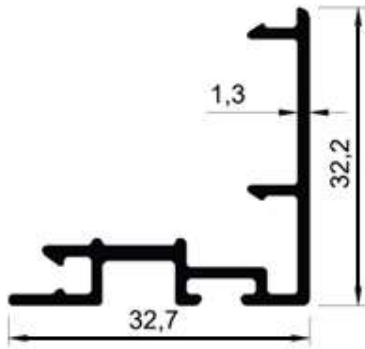

SL.NO.	SECTION NO.	WEIGHT(KG/M)
1	2823	0.428

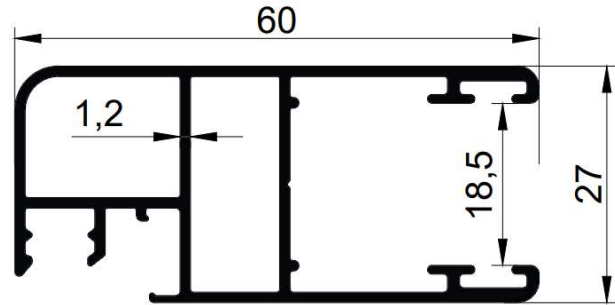

SL.NO.	SECTION NO.	WEIGHT(KG/M)
1	2824	0.748

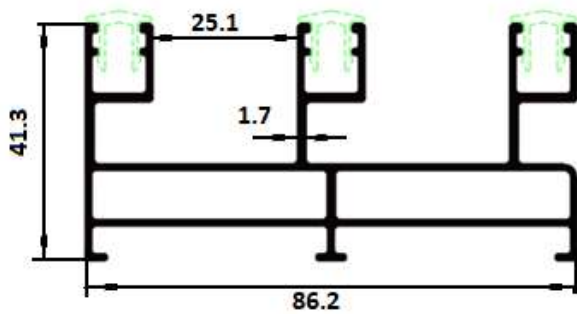

SL.NO.	SECTION NO.	WEIGHT(KG/M)
1	2897	1.415

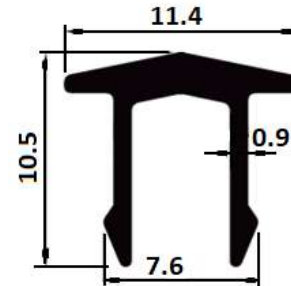

SL.NO.	SECTION NO.	WEIGHT(KG/M)
1	2899	0.090

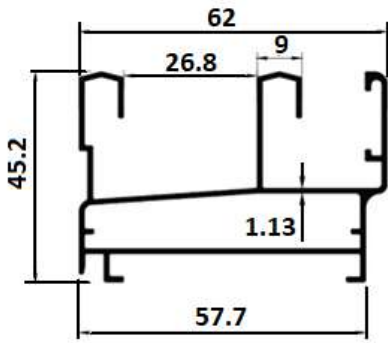

SL.NO.	SECTION NO.	WEIGHT(KG/M)
1	2825	0.885

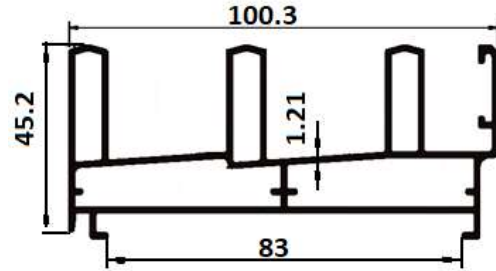

SL.NO.	SECTION NO.	WEIGHT(KG/M)
1	2826	1.539

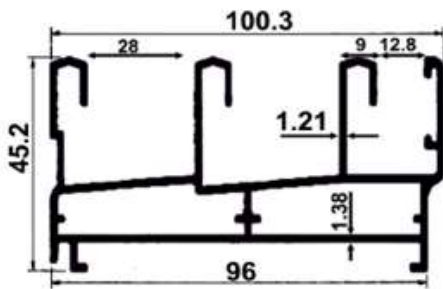

SL.NO.	SECTION NO.	WEIGHT(KG/M)
1	2827	1.379

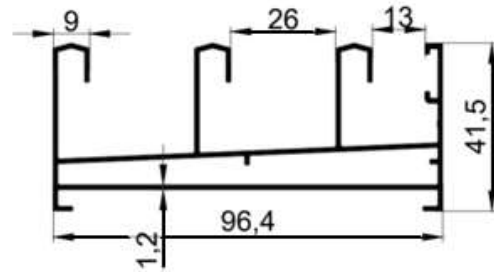

SL.NO.	SECTION NO.	WEIGHT(KG/M)
1	2870	1.260

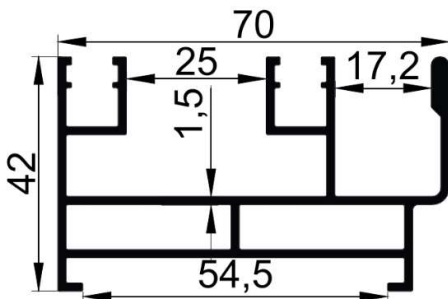

SL.NO.	SECTION NO.	WEIGHT(KG/M)
1	2709	1.269

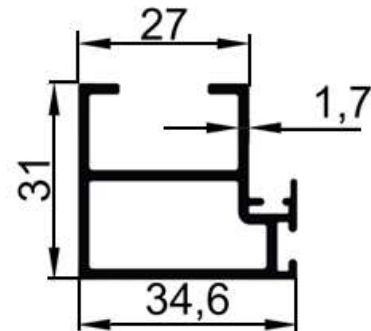

SL.NO.	SECTION NO.	WEIGHT(KG/M)
1	2777	0.644

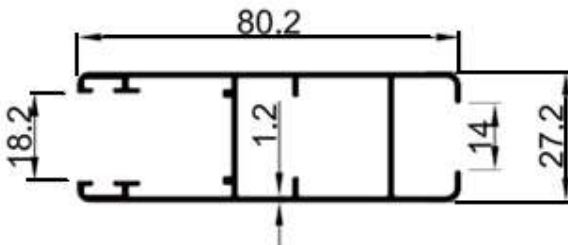

SL.NO.	SECTION NO.	WEIGHT(KG/M)
1	2776	0.836

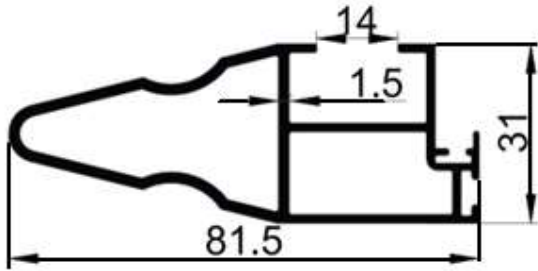

SL.NO.	SECTION NO.	WEIGHT(KG/M)
1	2779	1.128

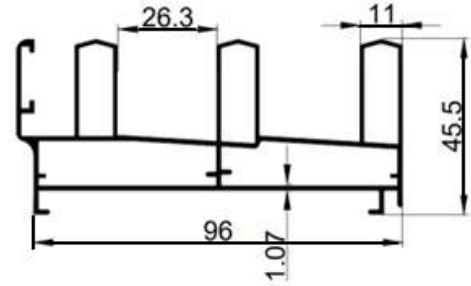

SL.NO.	SECTION NO.	WEIGHT(KG/M)
1	2780	1.347

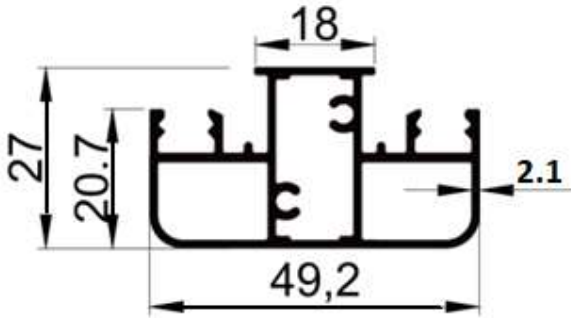

SL.NO.	SECTION NO.	WEIGHT(KG/M)
1	2784	0.763

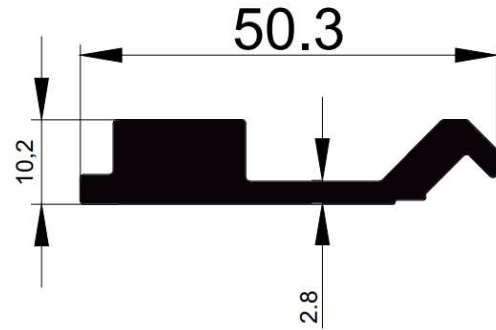

SL.NO.	SECTION NO.	WEIGHT(KG/M)
1	1098	0.798

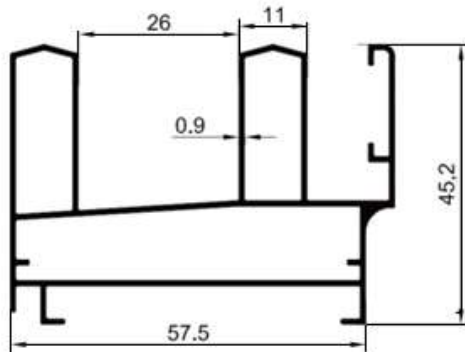

SL.NO.	SECTION NO.	WEIGHT(KG/M)
1	2778	0.800

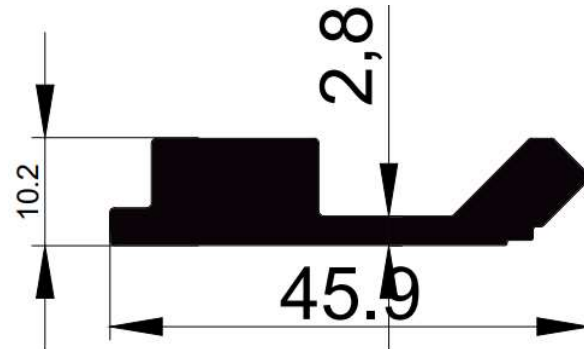

SL.NO.	SECTION NO.	WEIGHT(KG/M)
1	1099	0.789